

LIMBUS

CONTROL YOUR LIGHT

BY  *TD Lighting Solutions*

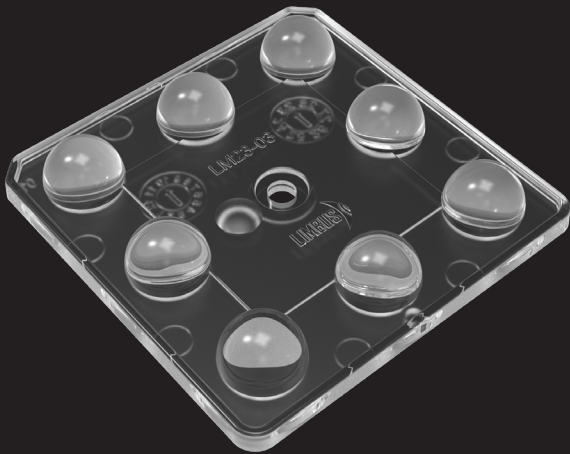

TLS08NI-5050-60-MB

- NICHIA NVSW219F V2
- LUXEON 5050 HE 6V

TLS08NI-5050-60-MB
with NICHIA NVSW219F V2
 LED OPTIC DATASHEET

www.limbus.com.tr
 444 27 33

LIMBUS
 CONTROL YOUR LIGHT

PRODUCT PICTURE

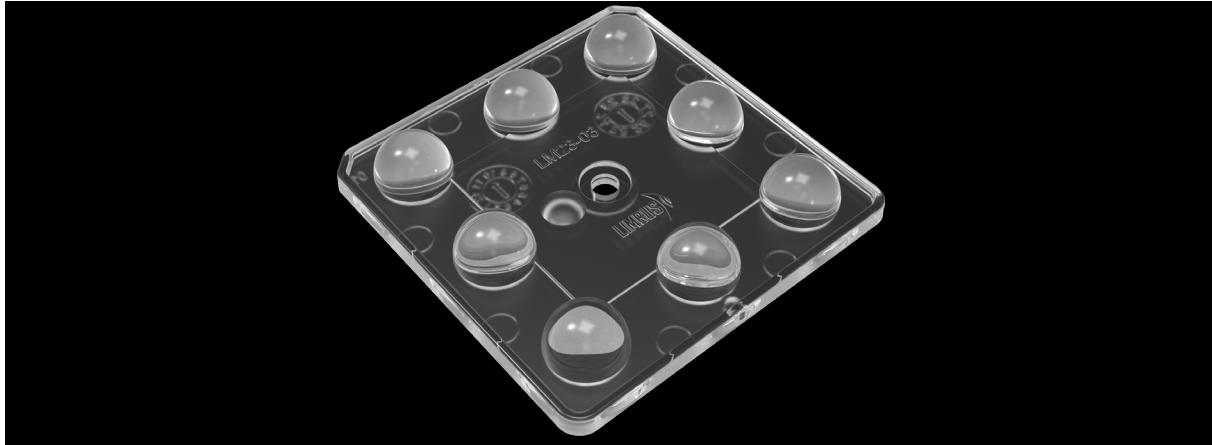

GENERAL SPECIFICATIONS

Product Code	TLS08NI-5050-60-MB
Application	Highbay
Degree (FWHM)	60°
Efficiency	92%
Type	8in1
Size (mm) W x L x H	50x50x7.3
Material / Operating Temp.	PMMA -40 ° C / +90 ° C max
Fastening	Screw, Pin
Rohs Complaint	Yes
Storage Temperature	0 ° C ~ 40 ° C max

PHOTOMETRIC SPECIFICATIONS

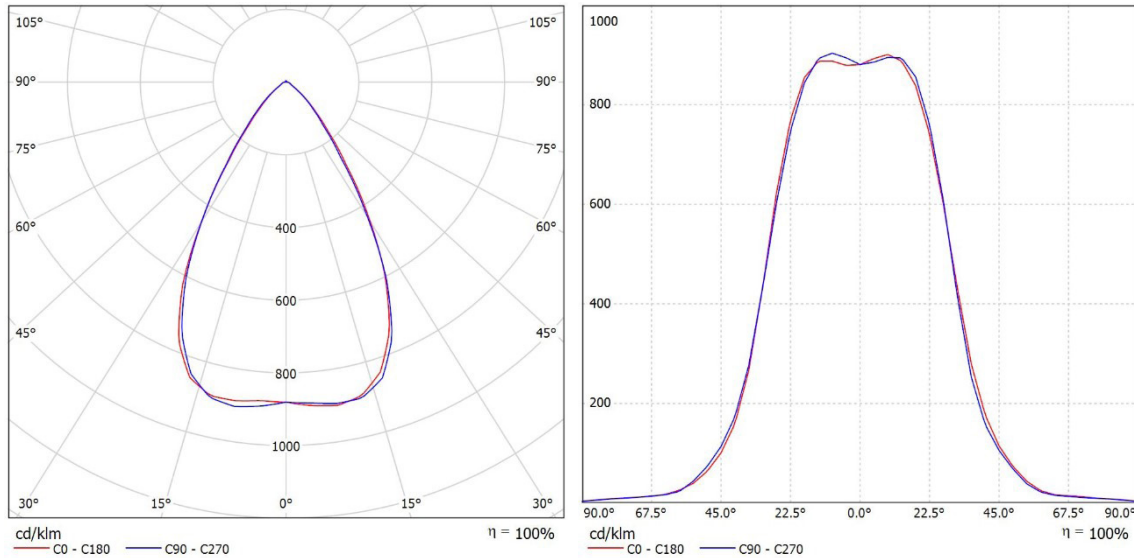

APPLICATION NOTES

- Please use a litter water and soft fabric (air-laid paper) to clean the lens & reflector if necessary.
- Forbid to use industrial solvent to clean the lens, such as alcohol.
- Storage environment temperature is 0°C~40°C, humidity is 30%~95%.
- Optic Lens has the function to change the ray of light, it is made of optical material, the effect shall be influenced once pollute. Please do not open the packing before use it, to avoid the dust pollution.
- Protect the product from the sun and other ultraviolet ray, as these will lead to aging, change color, crack, etc.
- Please ware gloves once install the lens, avoid to abrasion the lens surface.
- Forbid to use acidic or alkaline solution touch the product, avoid to generate the chemical reactions.

TLS08NI-5050-60-MB
with LUXEON 5050 HE 6V
 LED OPTIC DATASHEET

www.limbus.com.tr
 444 27 33

LIMBUS
 CONTROL YOUR LIGHT

PRODUCT PICTURE

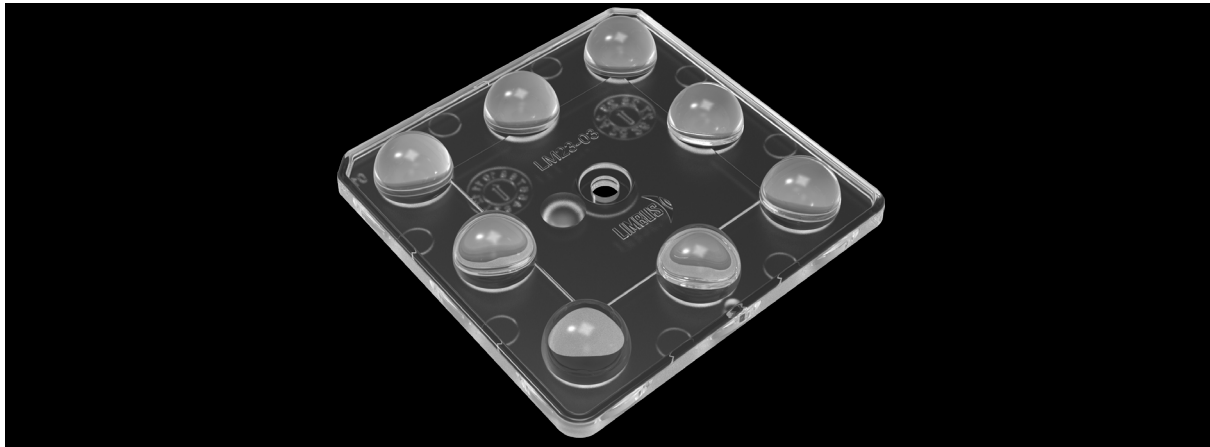

GENERAL SPECIFICATIONS

Product Code	TLS08NI-5050-60-MB
Application	Highbay
Degree (FWHM)	51°
Efficiency	92%
Type	8in1
Size (mm) W x L x H	50x50x7.3
Material / Operating Temp.	PMMA -40 °C / +90 °C max
Fastening	Screw, Pin
Rohs Complaint	Yes
Storage Temperature	0 °C ~ 40 °C max

PHOTOMETRIC SPECIFICATIONS

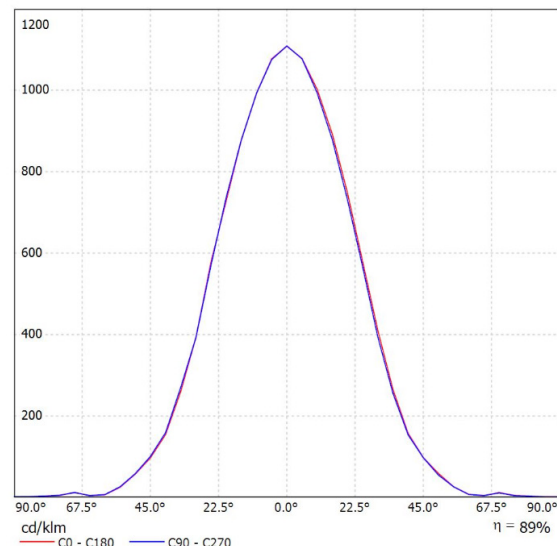
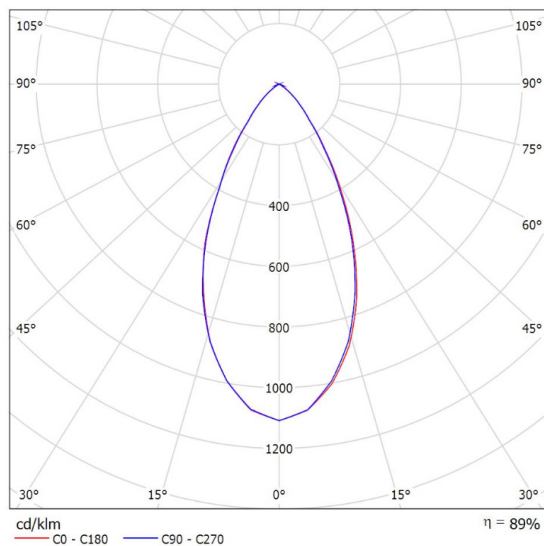

APPLICATION NOTES

- Please use a litter water and soft fabric (air-laid paper) to clean the lens & reflector if necessary.
- Forbid to use industrial solvent to clean the lens, such as alcohol.
- Storage environment temperature is 0°C~40°C, humidity is 30%~95%.
- Optic Lens has the function to change the ray of light, it is made of optical material, the effect shall be influenced once pollute. Please do not open the packing before use it, to avoid the dust pollution.
- Protect the product from the sun and other ultraviolet ray, as these will lead to aging, change color, crack, etc.
- Please ware gloves once install the lens, avoid to abrasion the lens surface.
- Forbid to use acidic or alkaline solution touch the product, avoid to generate the chemical reactions.

MECHANICAL DRAWINGS

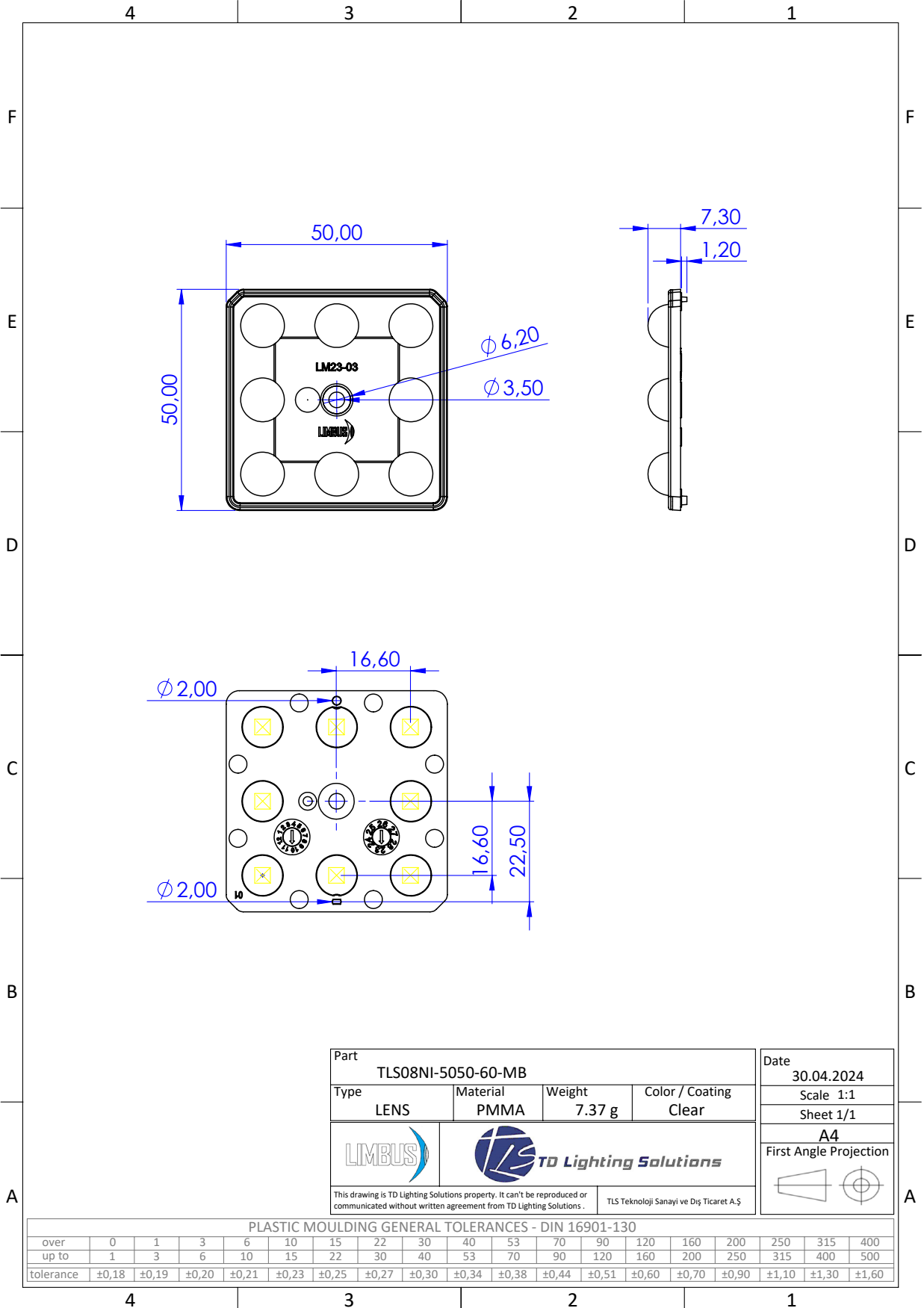

LEGAL NOTICE

Product information provided by TLS Teknoloji Sistemleri San ve Dış Tic AŞ ("TLS") in this document is believed to be correct and accurate. TLS reserves the right to change/correct the specifications and other data or information relating to products without notice but TLS accepts no liability for errors that may appear in this document, howsoever occurring, or liability arising from the use or application of any information or data provided herein. Neither the supply of such information, nor the purchase or use of products conveys any licence or permission under patent, copyright, trademark or other intellectual property right of TLS or third parties.

Products sold by TLS are subject to its standard Terms and Conditions of Sale that are available on request. No warranty is given that products do not infringe the intellectual property rights of third parties, and furthermore, the use of products in certain ways or in combination with TLS, or non-TLS furnished equipments/components may infringe intellectual property rights of TLS.

The purpose of this document is to provide information only and it may not be used, applied or reproduced (in whole or in part) for any purpose nor be taken as a representation relating to the products in question. No warranty or guarantee express or implied is made concerning the capability, performance or suitability of any product, and information concerning possible applications or methods of use is provided for guidance only and not as a recommendation. The user is solely responsible for determining the performance and suitability of the product in any application and checking that any specification or data it seeks to rely on has not been superseded.

Products are intended for normal commercial applications. For applications requiring unusual environmental requirements, extended temperature range, or high reliability capability (e.g. military, or medical applications), special processing/testing/conditions of sale may be available on application to TLS.

CONTACT

TLS Teknoloji Sistemleri San ve Dış Tic AŞ
Akçaburgaz Mahallesi 3080. Sokak No:5 Esenyurt / İstanbul / TURKEY

info@tlsteknoloji.com
+90 444 27 33